

BOTTLE LIFTERS

BOTTLE LIFTERS

- Manufactured to exceed all ASME B30.20 and OSHA regulations.
- Painted safety yellow for increased visibility.
- **ALL** Bottle Lifters proof loaded and shipped with certification paperwork.
- Durable construction ideally suited to jobsite or warehouse use.
- Made in U.S.A..
- Custom designs available - call for engineering.
- **ALL** lifting equipment individually proof loaded per OSHA requirements.

 Prop 65 – See Page 102

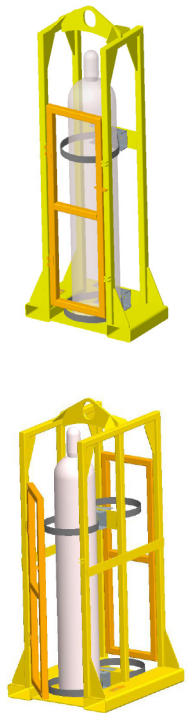

- Adjustable straps to hold tanks
- Lockable doors

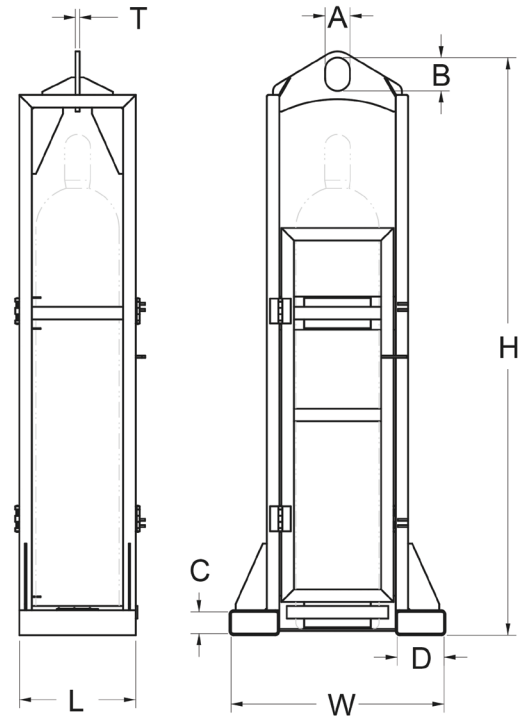
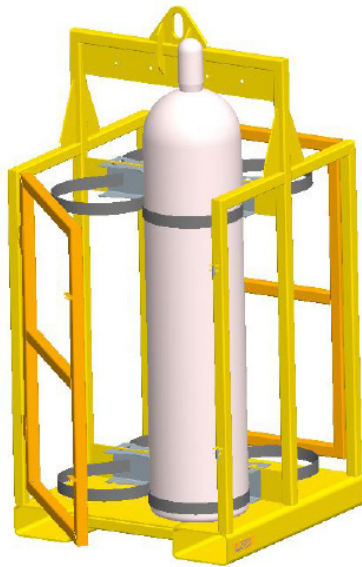

Part No.	Working Load Limit	Tank Capacity	A	B	C	D	T	L	W	H	WEIGHT
20199	500	1	3	4	2.62	5.62	0.5	14	26	70	150
16307	750	2	3	4	3	6	0.5	29.5	26	64.5	300
17324	1500	3	15	325	5	9	0.5	31	30.5	65	525

* Call for specifications on larger sizes and capacities