

SMALL FRAME BEAM CLAMPS

- Manufactured to exceed all ASME B30.20 and OSHA regulations.
- Painted safety yellow for increased visibility.
- Do not side load above angles of 45° from vertical.
- Durable construction ideally suited to jobsite or warehouse use.
- Made in U.S.A.
- Custom designs available - call for engineering.
- **ALL** lifting equipment individually proof loaded per OSHA requirements.

Prop 65 – See Page 112

- Refer to side loading table below for reduction factors for side loading applications.
- Clamps to be used for lifting, pulling or as an anchor point.
- Ratings apply to clamps only. User is responsible for engineering calculations for all support steelwork.

WARNING: All clamps must be correctly applied to the beam by a competent person and fully hand tightened. If in doubt, contact M&W for recommendations.

Reduction in Working Load Limits when side loads are applied				
Angle from Vertical	0°	0 - 15°	15 - 30°	30 - 45°
Reduction factor	none	20%	35%	50%

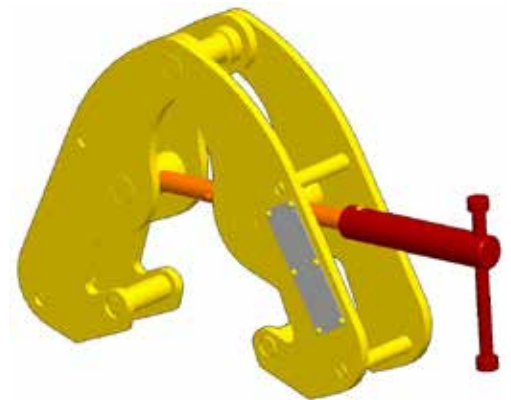
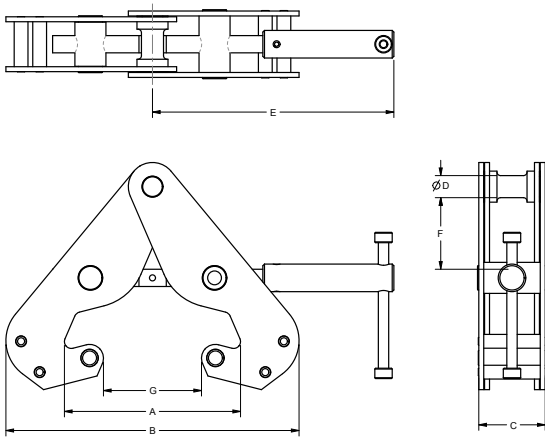

Working Load Limit in Pounds*	Part Number	A	B	C	D	E	F	G	Weight	Maximum Flange Thickness	Minimum Flange Thickness	Maximum Flange Width	Minimum Flange Width	Maximum Slip Over Width
2,240	13474	10.94	14.59	2.41	0.80	8.75	1.35	8.33	8.3	1.21	0.81	9.50	3.20	8.85
2,240†	13510	15.74	20.52	2.94	0.80	10.63	1.65	13.42	13.8	1.45	0.75	13.50	3.75	11.50
4,480	13486	10.94	14.59	2.94	0.80	8.75	1.35	8.33	10.4	1.21	0.87	9.60	3.20	9.00
4,480†	13553	15.74	20.52	3.19	0.80	10.63	1.65	13.42	16.1	1.45	0.81	14.50	3.50	14.00
6,720	13497	15.11	19.53	3.94	1.05	10.13	2.41	12.51	21.4	1.63	1.13	14.00	5.00	13.25
11,200	13648	15.11	19.53	4.19	1.38	10.13	2.24	12.51	25.6	1.63	1.13	14.00	4.25	13.00

*Call for specifications on larger sizes and capacities. † Indicates beam clamp for use on wide flange beams.